

VRF Indoor

TVRF-IEHESP D42KHP

Indoor VRF SYSTEM FEATURES

- High Static Pressure Design
- Easy Maintenance
- Convenient Installation
- Protection Functions



Specifications		Model Name
Unit Type		TVRF-IEHESP D42KHP
Cooling Capacity	Btu/h	42,000
Heating Capacity	Btu/h	47,000
External Dimensions (WxHxD)	In.	48-3/8 x 11-3/8 x 30-1/2
	mm	1229 x 290 x 775
Net Weight	Lbs. / Kg	104/47
Electrical Power Requirements	Voltage, Phase, Hertz	208/230V, 1-phase, 60HZ
Power Cooling Consumption	kW	0.22
Power Heating Consumption	kW	0.22
Current Cooling	A	1.6
Current Heating	A	1.6
Minimum Circuit Ampacity (MCA)	A	3.15
Max. Overcurrent Protection (MOCP) Fuse	A	6
Refrigerant Piping Dimensions (In./mm)	Liquid (High Pressure)	3/8 - 9.52
	Gas (Low Pressure)	5/8 - 15.9
Sound Pressure Level	dB(A)	48/45/42
Fan		
Type x Quantity		Centrifugal x 2
Airflow Rate	CFM	1180/912/706
Motor		
Motor Type x Quantity		Direct Drive x 1
Motor Output	kW	0.25
Refrigerant		R410A
Coil Type		internal groove tube

Job Name:

Date:

System Reference No.:

Engineer Signature:

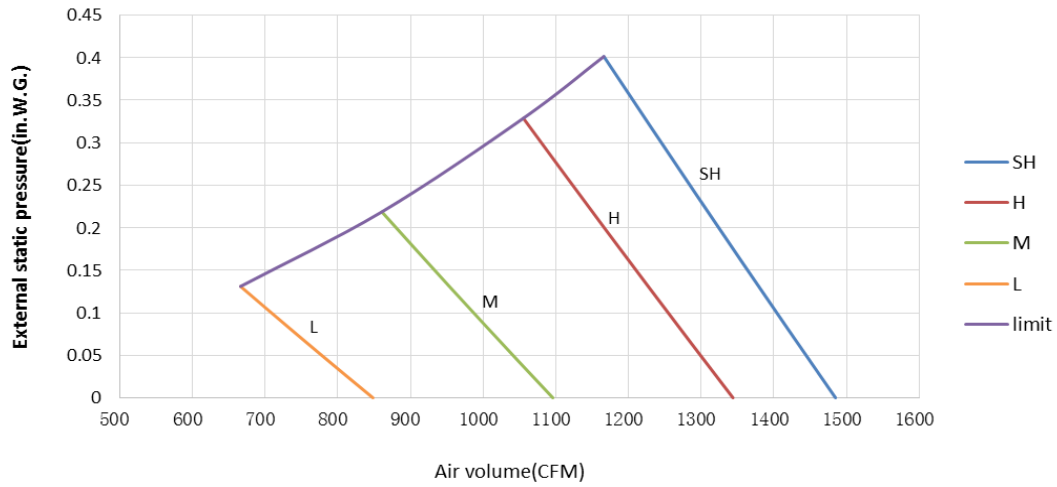

Outline Dimension Diagram

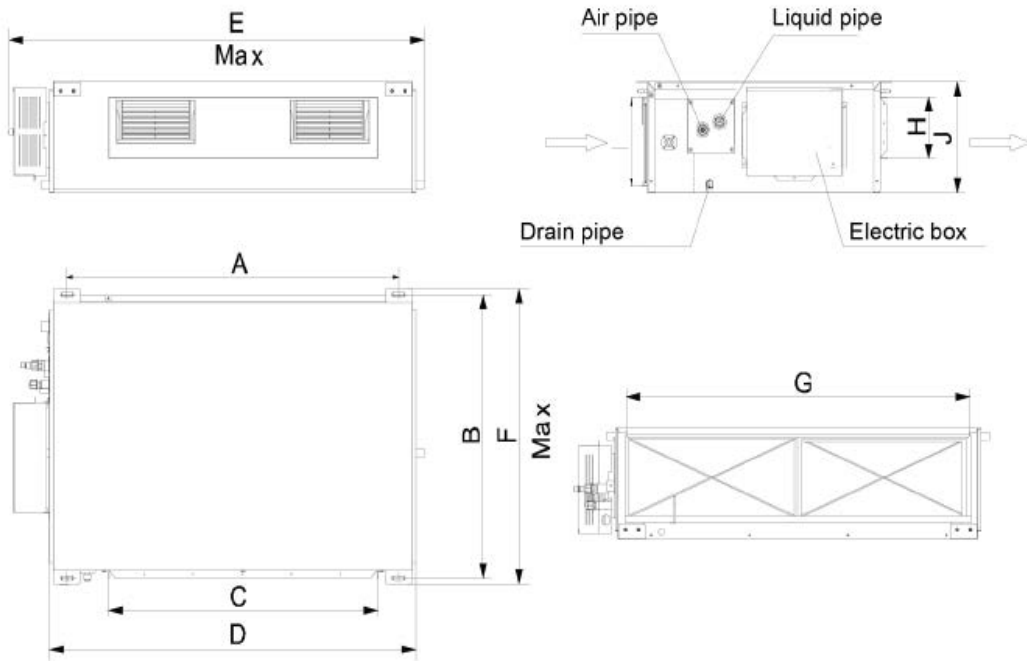

	A	B	C	D	E
mm	1011	748	820	1115	1229
inch	43 3/8	29 1/2	32 1/4	43 7/8	48 3/8
	F	G	H	I	J
mm	775	979	160	231	290
inch	30 1/2	38 1/2	6 1/4	9 1/8	11 3/8

